

JLBIOS664 OVEN

Instruction manual

GB

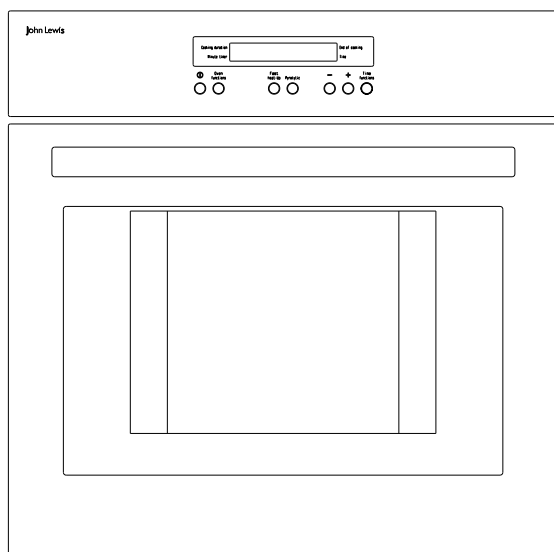

John Lewis

Contents

Important safety information	3
Description of the appliance	5
Control panel	6
The oven safety devices	7
When the oven is first installed	8
Before first use	8
Function symbols	11
Programming the oven	12
Special and Energy Saving functions	14
Using the oven	17
Baking Table	22
Roasting Table	23
Cleaning and Maintenance	25
Pyrolytic cleaning	26
Something not working	35
Technical data	36
Electrical Connection	37
Instructions fo Building In	38

Guide to using the user instructions



Safety instructions



Step by step instructions



Hints and Tips



Environmental Informations



This appliance conforms with the following ECC Directives:

- 2006/95 (Low Voltage Directive);
 - 2004/108 (EMC Directive);
- and subsequent modifications.



Important Safety Information

These warnings are provided for the safety of the users and those living with them. So read them carefully before installing and using the appliance.

This will allow you to obtain best performance, avoid improper actions, use the appliance in complete safety and also respect the environment.

If you need assistance, contact our Customer Care Department on 08705 727 727

Installation

- This oven must be installed by qualified personnel to the relevant British Standards.
- This oven is heavy. Take care when moving it.
- Remove all packaging, both inside and outside the oven, before using the oven.
- Do not attempt to modify the oven in any way.
- Do not hang towels, dishcloths or clothes from the oven or its handle.
- Do not use this oven if it is in contact with water and never operate it with wet hands.
- Take great care when heating fats and oils as they will ignite if they become too hot.
- Always use oven gloves to remove and replace food in the oven.

During use

- This oven is intended for domestic cooking only. It is not designed for commercial or industrial purposes.
- Always stand back from the oven when opening the oven door during cooking or at the end of it to allow any build up of steam or heat to release.
- Appliances become very hot with use, and retain their heat for long periods after use. Care should be taken to avoid touching heating elements inside the oven.
- Never line any part of the oven with aluminium foil.
- Do not allow heatproof cooking material, e.g. roasting bags, to come into contact with oven elements.
- Never place plastic or any other material which may melt in or on the oven.
- Do not place sealed cans or aerosols inside the oven. They may explode if they are heated.
- Before cleaning the oven, either turn the power off or pull the mains plug out.
- Ensure that all controls are in the OFF position when not in use.
- Do not leave cookware containing foodstuffs, e.g. fat or oil in or on the oven in case it is inadvertently switched ON.
- When using other electrical appliances, ensure the cable does not come into contact with the hot surfaces of the oven.

People Safety

- This oven is designed to be operated by adults. Do not allow children to play near or with the oven.
- The oven gets hot when it is in use. Children should be kept away until it has cooled.
- This appliance is not intended for use by children or other persons whose physical, sensory or mental capabilities or lack of experience and knowledge prevents them from using the appliance safely without supervision or instruction by a responsible person to ensure that they can use the appliance safely.

Maintenance and Cleaning

- Only clean this oven in accordance with the instructions.
- Always allow the oven to cool down and switch off the electrical supply before carrying out any cleaning or maintenance work.
- The oven should be kept clean at all times. A build-up of fats or other foodstuffs could result in a fire, especially in the grill pan.
- Never use steam or high pressure steam cleaners to clean the appliance.
- Do not use abrasive cleaners or sharp metal scrapers. These can scratch the glass in the oven door, which may result in the shattering of the glass.

Service

- This oven should only be repaired or serviced by an authorised Service Engineer and only genuine approved spare parts should be used.



Environmental Information

- After installation, please dispose of the packaging with due regard to safety and the environment.
- When disposing of an old appliance, make it unusable, by cutting off the cable. Remove any door catches, to prevent small children being trapped inside.



The symbol  on the product or on its packaging indicates that this product may not be treated as household waste. Instead it shall be handed over to the applicable collection point for the recycling of electrical and electronic equipment. By ensuring this product is disposed of correctly, you will help prevent potential negative consequences for the environment and human health, which could otherwise be caused by inappropriate waste handling of this product.

For more detailed information about recycling of this product, please contact your local city office, your household waste disposal service or the shop where you purchased the product.

Always keep these user instructions with the appliance. Should the appliance be passed on to third persons or sold, or if you leave this appliance behind when you move house, it is very important that the new user has access to these user instructions and the accompanying information.

Description of the appliance

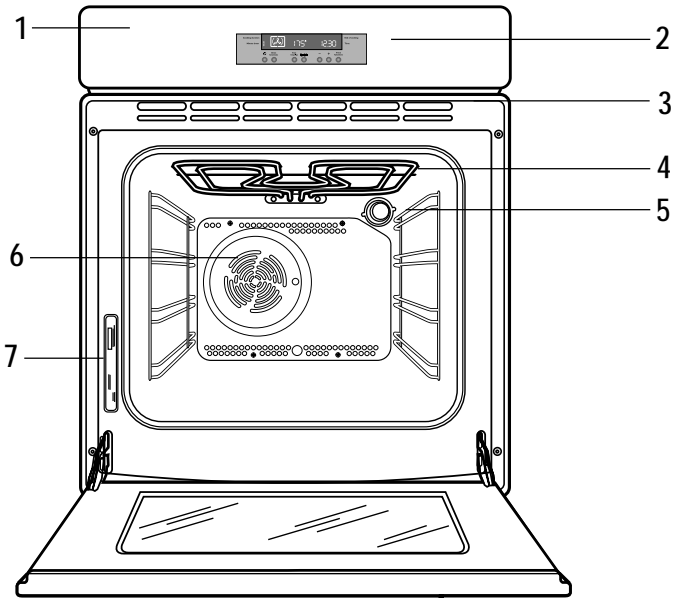

- 1. Control Panel
- 2. Electronic programmer
- 3. Air Vents for Cooling Fan
- 4. Grill
- 5. Oven light
- 6. Oven Fan
- 7. Rating plate

Oven accessories

Grill/roasting pan

Grill trivet

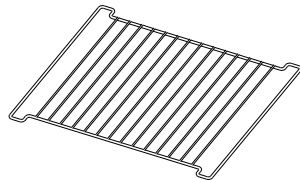
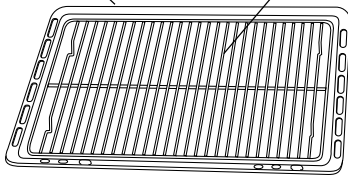

Shelves

Control panel

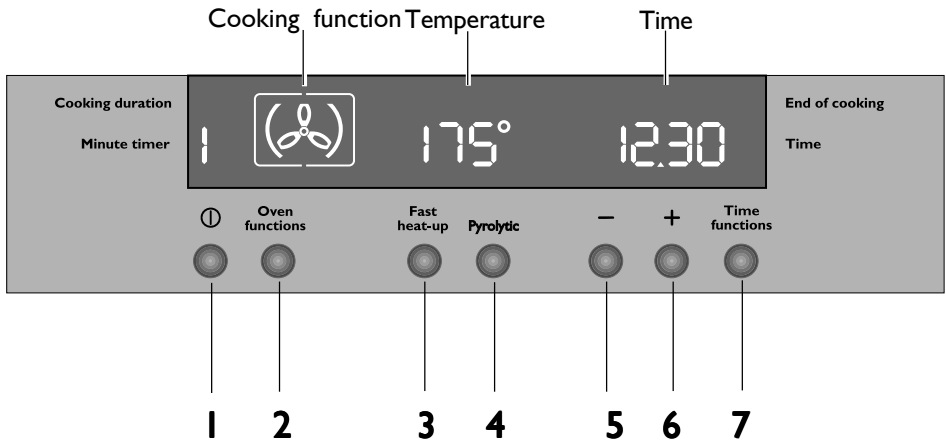

1. ON / OFF Control
2. Oven functions Control
3. Fast heat-up Control
4. Pyrolytic Function Control
5. Decreasing Control "—" (Time or Temperature)
6. Increasing Control "+" (Time or Temperature)
7. Time functions Control (Minute timer / Cooking duration function / End of cooking function)

All the oven functions are controlled by an electronic programmer.

You can select any combination of cooking function, cooking temperature and automatic timing.

NOTE

In the event of a power failure, the programmer will keep all the settings (time of day, programme setting or programme in operation) for about 3 minutes. If power fails for a longer time, all the settings will be cancelled. When the power is restored, the numbers in the display will flash, and the clock/timer has to be reset.

The oven safety devices

Safety thermostat

To prevent dangerous overheating (through incorrect use of the appliance or defective components), the oven is fitted with a safety thermostat, which interrupts the power supply. The oven switches back on again automatically, when the temperature drops.

Should the safety thermostat trigger due to incorrect use of the appliance, it is enough to remedy the error after the oven has cooled down; if on the other hand, the thermostat triggers because of a defective component, please contact the local customer service.

The cooling fan

The cooling fan is designed to cool the oven and the control panel. The fan switches on automatically after a few minutes of cooking. Warm air is blown out through the aperture near the oven door handle. When the oven is switched off, the fan may run on after the oven is switched off to keep the controls cool. This is quite normal.



The action of the cooling fan will depend on how long the oven has been used and at what temperature. It may not switch in at all at lower temperature settings nor run on where the oven has only been used for a short time.

When the oven is first installed



Remove all packaging, both inside and outside the oven, before using the oven.

When the oven is first connected to the electrical supply, the display will automatically show 12:00 and the symbol  will flash.

Ensure the correct time of day is set before using the oven.

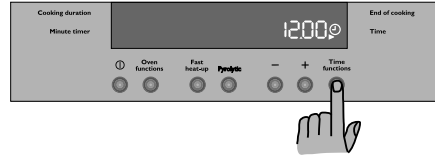

To set the correct time of day:

a) while the symbol  is flashing, set the correct time of day by pressing buttons "—" or "+".

The time arrow symbol  will disappear about 5 seconds after the correct time is displayed.

b) if the symbol  is not flashing anymore, press Time Functions button twice.

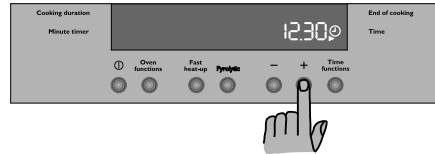

Then, proceed as described in point a).





Before first use

The oven should be heated without food.

To do that, proceed as follows:

- press button  to switch on the oven.
- press Oven function button twice and select the "Conventional Cooking" function .
- set the temperature to 250 °C using the increasing push button "+".
- Allow the oven to run **empty** for approximately 45 minutes.
- open a window for ventilation.

This procedure should be repeated with the "Fan Cooking"  and "Full Grill"  function for approximately 5-10 minutes.

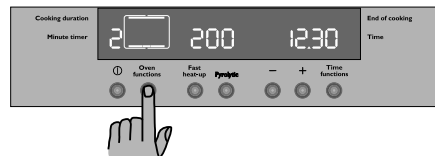

i During this time, an unpleasant odour may be emitted. This is absolutely **normal**, and is caused by residues of manufacturing.

Once this operation is carried out, let the oven cool down, then clean the oven cavity with a soft cloth soaked in warm water to which a little mild washing-up liquid has been added.

i Before cooking for the first time, carefully wash the **shelves** and the **baking tray**.

! To open the oven door, always hold the handle in the centre.

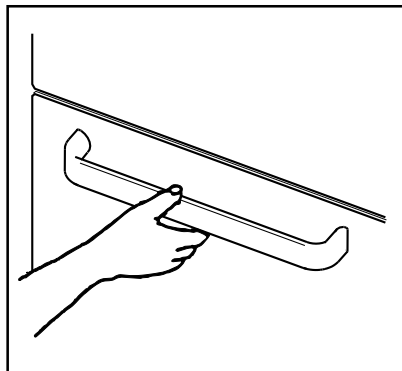

"On/Off" Push Button

The oven must be switched on before setting any cooking function or programme. When button **1** is pressed, the oven symbol will appear in the display, and the oven light will switch on.

To switch off the oven, you can press button **1** at any time. Any cooking function or programme will stop, the oven light will switch off and the time display will show the time of day only.

It is possible to switch off the oven at any time.

How to select a Cooking Function

1) Switch on the oven by pressing the **1** button.

2) Press Oven function button to select the required oven function. Each time Oven function button is pressed, a cooking symbol will appear in the display and the corresponding cooking function number will appear to the left of the currently selected cooking function symbol.

3) If the pre-set temperature is not suitable, press button "**-**" or "**+**" to adjust the temperature in 5 degree steps.

- as soon as the oven heats up, the thermometer symbol rises slowly , indicating the degree to which the oven is currently heated;

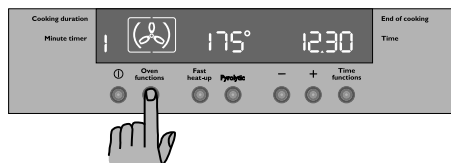

When the required temperature is reached, an acoustic alarm will sound for a short time and the thermometer symbol  will illuminate permanently.

How to set the Temperature

Press button “-” and “+” to increase or decrease the pre-set temperature while the “o” symbol is flashing.

 If symbol “o” is not flashing, press Oven function button once.

The maximum temperature is 250°C.

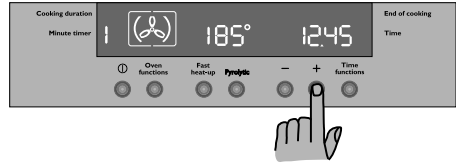



Function Symbols

1  **Fan cooking** - This setting allows you to roast or roast and bake simultaneously using any shelf, without flavour transference. Pre-set temperature: 175 °C

2  **Conventional cooking** - The heat comes from both the top and bottom element, ensuring even heating inside the oven. Pre-set temperature: 200 °C

3  **Full Grill** - The full grill element will be on. Recommended for large quantities. Pre-set temperature: 250 °C. Temperature adjustment range: from minimum 200°C to maximum 250°C.

4  **Inner Grill** - can be used for grilling small quantities. Pre-set temperature: 250 °C. Temperature adjustment range: from minimum 200°C to maximum 250°C.

5  **Thermal Grilling** - This function offers an alternative method of cooking food items, normally associated with conventional grilling. The grill element and the oven fan operate together, circulating hot air around the food. Pre-set temperature: 180 °C

Select a maximum temperature of 200°C.

6  **Pizza Oven** - The bottom element provides direct heat to the base of pizzas, quiches or pies, while the fan ensures air is circulated to cook the pizza toppings or pie fillings. Pre-set temperature: 175 °C

7  **Bottom heating element** - The heat comes from the bottom of the oven only, to allow you to finish your dishes. Pre-set temperature: 250 °C

8  **Top heating element** - The heat comes from the top of the oven only, to allow you to finish your dishes. Pre-set temperature: 250 °C

9  **Defrosting** – The oven fan operates without heat and circulates the air, at room temperature, inside the oven. This function is particularly suitable for defrosting delicate food which could be damaged by heat, e.g. cream filled gateaux, iced cakes, pastries, bread and other yeast products.

10  **Pyrolytic Cleaning** - This function allows you to clean thoroughly the oven cavity.

Programming the Oven

How to set the minute minder

- 1) Press Time Functions button to select the Minute Minder function. The relevant  symbol will flash and the control panel will display "0.00".
- 2) Press button "+" to select the required time. Maximum time is 23 hours 59 minutes. After it has been set, the Minute Minder will wait 3 seconds and then start running.
- 3) When the programmed time has elapsed, an acoustic alarm will be heard.
- 4) To switch off the acoustic alarm, press any button.

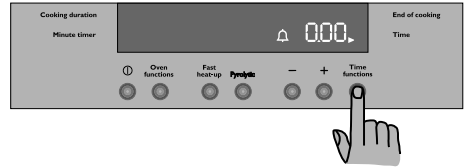

 The oven will NOT switch off if in use. The Minute Minder function can also be used as well when the oven is off.

To use or to change the Minute Minder setting:

press Time Functions button until the symbols  and  flash.

It is now possible to change the Minute Minder setting by pressing button "-" or "+".

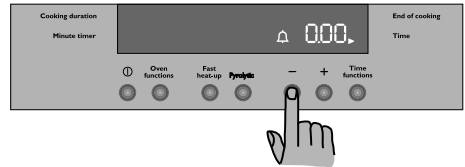

To cancel the Minute Minder:

press Time Functions button until the symbols  and  flash.

Press button "-" to decrease the time until "0.00" is displayed.



To programme the Oven to switch off

- 1) Place food in the oven, switch on the oven, select a cooking function and adjust the cooking temperature, if required.
- 2) Press Time Functions button to select the "Cooking Duration" function (Fig. 9). The "Cooking Duration" symbol  will flash and the control panel will display "0.00".

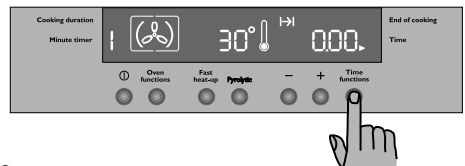

- 3) While the symbol ► is flashing, press button "➕" to select the required time. Maximum time is 23 hours 59 minutes. The programmer will wait 3 seconds and then start running.
- 4) When cooking time is over, the oven will be switched off automatically and an acoustic alarm will be heard while the control panel will display "0.00".
- 5) To switch off the acoustic alarm, press any button.

To cancel the Cooking Duration Time:

- press Time Functions button until the symbol ► will flash.
- press button "—" to decrease the time until "0.00" is displayed.

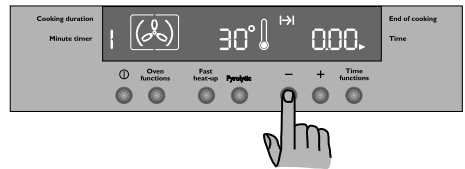

To Programme the Oven to Switch On and Off

- 1) Carry out the "Cooking Duration" setting as described in the relevant chapter.
- 2) Press Time Functions button until the "End of Cooking" function → is selected and the relevant symbol flashes. The control panel will display the end of cooking time (that is, the actual time + cooking duration time).
- 3) Press button "➕" to select the required end of cooking time.
- 4) After this is set, the programmer will wait 3 seconds and then start running.
- 5) The oven will switch on and off automatically. The end of cooking will be marked by an acoustic alarm.
- 6) To switch off the acoustic alarm, press any button.

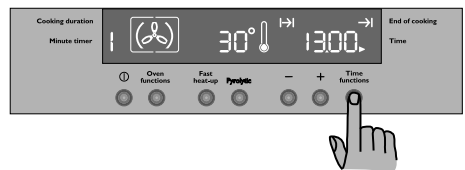

To cancel the programme, simply cancel the Duration Time.

Special and Energy Saving Functions

Automatic Cut-Off Function

The oven will switch off automatically if any change of setting is made, according to the table below.

If temperature setting is:	the oven will switch off:
250°C	after 3 hours
from 200 up to 245°C	after 5,5 hours
from 120 up to 195°C	after 8,5 hours
less than 120°C	after 12 hours



Residual Heat Function

When a Cooking Duration time is set, the oven will automatically switch off a few minutes before the end of the programmed time, and use the residual heat to finish your dishes without energy consumption. All current settings will be displayed until the Cooking Duration time is over.

This function will not operate when the Cooking Duration time is less than 15 minutes.

Child Lock Function

To avoid children switching on the oven, it is possible to lock the oven controls.

i The oven must be off for the Child Lock Function to be activated. If the oven is on, turn it off by pressing button **ⓘ**.

1. Press Oven function buttons and "—" at the same time and keep them pressed for about 3 seconds. An acoustic signal will be emitted and the indication 'SAFE' will appear on the display.
2. The oven is now locked. Neither oven functions nor temperatures can be selected.

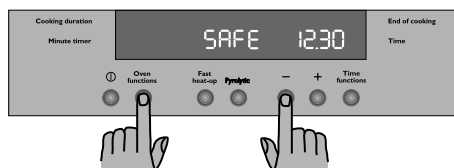

To unlock the oven:

Press Oven function buttons and "—" at the same time and keep them pressed for about 3 seconds. An acoustic signal will be emitted and the indication 'SAFE' will go off. The oven can now be operated.

"Fast Heat Up" function

After a cooking function has been selected and the temperature has been adjusted, the cavity will gradually heat up until the selected temperature is reached. This will take from 10 to 15 minutes, depending on selected function and temperature. If it is necessary to reach the required temperature in a shorter time, the "Fast Heat Up" Function can be used.

- 1) Switch the oven on by pressing button ①.
- 2) Set the required cooking function and temperature as explained in the previous pages.
- 3) Set the temperature by pressing button "—" or "+". The temperature will appear on the display.
- 4) Press Oven function button. The temperature display will show "FHU".
- 5) press Oven function button and the symbol "°" will flash for approximately 10 seconds. Now it is possible to select the required temperature by pressing button "—" or "+".
- 6) When the required temperature is reached, an acoustic alarm will sound for a short time, and the temperature display will revert to the set temperature.

This function can be used with any cooking function or temperature.

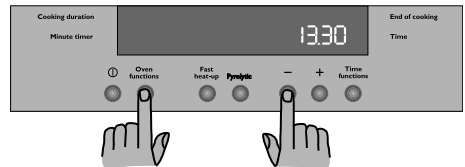

Demo mode

This mode is intended to be used in shops to demonstrate the oven functionality without any power consumption except the interior light, the display and the fan. This function can only be switched on when the appliance is first connected.

If there is a power failure, when the power supply is restored again, the Demo function can only be switched on if in the display 12:00 and the symbol  are flashing automatically.

1. Press the Time functions button for approximately 2 seconds. An acoustic alarm will sound for a short time.
2. Press the Time Functions and "**—**" buttons at the same time. A short acoustic alarm will be heard and the time 12:00 will appear in the display.

When the oven is switched on the symbol  appears in the display. This means that the Demo function is activated.

All oven functions can be selected.

The oven is not really working and the heating elements do not switch on.

Switch off the oven and follow the procedure described above to switch off the demo mode again.

 The Demo function remains saved in the programme in the event of a power failure.

Error code

The electronic programmer does a continuous diagnostic check of the system. If some parameters are not correct, the control unit will stop the activated functions and it will show on the display the corresponding error code.

For further details, refer to chapter "Something not working".

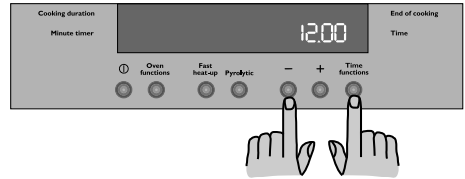

Beep mode

You can choose to make The Electronic Control beep each time that a control is touched.

 To enable this function, the oven must be off.

Press controls **Oven function** and "**+**" at the same time for about 3 seconds. The Electronic Control beeps once.

To disable the "Beep" Function:

1. If the oven is on, press control  to switch it off.
2. Press controls **Oven function** and "**+**" at the same time for about 3 seconds. The Electronic Control beeps once.

Using the oven

The oven is supplied with an exclusive system which produces a natural circulation of air and the constant recycling of steam.

This system makes it possible to cook in a steamy environment and keep the dishes soft inside and crusty outside. Moreover, the cooking time and energy consumption are reduced to a minimum. During cooking steam may be produced which can be released when opening the oven door. This is absolutely normal.



However, always stand back from the oven when opening the oven door during cooking or at the end of it to allow any build up of steam or heat to release.



Attention! - Do not place objects on the oven base and do not cover any part of the oven with aluminium foil while cooking, as this could cause a heat build-up which would affect the baking results and damage the oven enamel. Always place pans, heat-resisting pans and aluminium trays on the shelf which has been inserted in the shelf runners. When food is heated, steam is created, like in a kettle. When the steam comes into contact with the glass in the oven door, it condenses and creates water droplets.

To reduce condensation, always preheat the empty oven for 10 minutes.

We recommend you wipe the water droplets away after every cooking process.



Always cook with the oven door closed. Stand clear when opening the drop down oven door. **Do not** allow it to fall open - support the door using the door handle, until it is fully open.

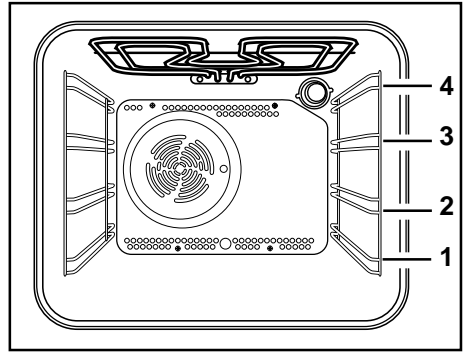

The oven has four shelf levels.

The shelf positions are counted from the bottom of the oven as shown in the diagram.

It is important that these shelves are correctly positioned as shown in the diagram.

Do not place cookware directly on the oven base.

Fan cooking

The air inside the oven is heated by the element around the fan situated behind the back panel. The fan circulates hot air to maintain an even temperature inside the oven.

The advantages of cooking with this function are:

Faster Preheating

As the fan oven quickly reaches temperature, it is not usually necessary to preheat the oven although you may find that you need to allow an extra 5-7 minutes on cooking times. For recipes which require higher temperatures, best results are achieved if the oven is preheated first, e.g. bread, pastries, scones, souffles, etc.

Lower Temperatures

Fan oven cooking generally requires lower temperatures than conventional cooking. Follow the temperatures recommended in the cooking chart. Remember to reduce temperatures by about 20-25 °C for your own recipes which use conventional cooking.

Even Heating for Baking

The fan oven has uniform heating on all shelf positions. This means that batches of the same food can be cooked in the oven at the same time. However, the top shelf may brown slightly quicker than the lower one.

This is quite usual. There is no mixing of flavours between dishes.

How to use the fan oven

1. Switch the oven on.
2. Select the fan cooking function by pressing the Oven function control until the symbol  appears in the display.
3. If necessary adjust temperature setting using the "+" or "-" controls.

Conventional Cooking

- The middle shelf position allows for the best heat distribution. To increase base browning simply lower the shelf position. To increase top browning, raise the shelf position.
- The material and finish of the baking trays and dishes used will affect base browning. Enamelware, dark, heavy or non-stick utensils increase base browning, while oven glassware, shiny aluminium or polished steel trays reflect the heat away and give less base browning.
- Always place dishes centrally on the shelf to ensure even browning.
- Stand dishes on suitably sized baking trays to prevent spillage onto the base of the oven and make cleaning easier.
- **Do not** place dishes, tins or baking trays directly on the oven base as it becomes very hot and damage will occur. When using this setting, heat comes from both the top and bottom elements. This allows you to cook on a single level and is particularly suitable for dishes which require extra base browning such as quiches and flans.

Gratins, lasagnes and hotpots which require extra top browning also cook well in the conventional oven.

How to use the conventional oven

1. Switch the oven ON.
2. Select the conventional cooking function by pressing the Oven function control until the symbol  appears in the display.
3. If necessary adjust temperature setting using the "+" or "-" controls.

Top heating element

This function is suitable for finishing cooked dishes, e.g. lasagne, shepherds pie, cauliflower cheese etc.

Bottom heating element

This function is particularly useful when blind-baking pastry. It may also be used to finish off quiches or flans to ensure the base pastry is cooked through.

Grilling

- Most foods should be placed on the grid in the grill pan to allow maximum circulation of air and to lift the food out of the fats and juices. Food such as fish, liver and kidneys may be placed directly on the grill pan, if preferred.
- Food should be thoroughly dried before grilling to minimise splashing. Brush lean meats and fish lightly with a little oil or melted butter to keep them moist during cooking.
- Accompaniments such as tomatoes and mushrooms may be placed underneath the grid when grilling meats
- When toasting bread, we suggest that the top runner position is used.
- The food should be turned over during cooking, as required.

How to use the Full Grill

1. Switch the oven ON.
2. Select the double grill by pressing the Oven function control until the symbol  appears in the display.
3. If necessary adjust temperature setting using the "+" or "-" controls.
4. Adjust the grid and grill pan runner position to allow for different thicknesses of food. Position the food close to the element for faster cooking and further away for more gentle cooking.

Preheat the grill on a full setting for a few minutes before sealing steaks or toasting. Adjust the heat setting and the shelf as necessary, during cooking.

During cooking, the cooling fan and the thermostat control light will operate in the same way as described for the fan cooking function.

How to use the Inner Grill

The grill provides quick direct heat to the central area of the grill pan. By using the grill for cooking small quantities, it can help to save energy.

1. Switch the oven ON.
2. Select the grill element by pressing the Oven function control until the symbol  appears on the display.
3. If necessary adjust temperature setting using the "+" or "-" controls.
4. Adjust the grid and grill pan runner position to allow for different thicknesses of food and follow the instructions for grilling.

How to Use the Thermal Grilling

Thermal grilling offers an alternative method of cooking food items normally associated with conventional grilling. The grill element and the oven fan operate at the same time, circulating hot air around the food. The need to check and turn the food is reduced. Thermal grilling helps to minimise cooking smells in the kitchen.

With the exception of toast and rare steaks, you can thermally grill all the foods you would normally cook under a conventional grill. Cooking is more gentle, therefore food generally takes a little longer to cook with thermal grilling compared with conventional grilling. One of the advantages is that larger quantities can be cooked at the same time.

1. Switch the oven ON.
2. Select the thermal grill cooking function by pressing the Oven function control until the symbol  appears on the display.
3. If necessary, press "+" or "-" buttons. to adjust the temperature setting.



When using Thermal Grill, do not select temperatures over 200°C.

4. Adjust the grid and grill pan runner position to allow for different thicknesses of food and follow the instructions for grilling.

Pizza oven

The bottom element provides direct heat to the base of pizzas, quiches or pies, while the fan ensures air is circulated to cook the pizza toppings or pie fillings.

To obtain the best results use the lower shelf levels.

1. Switch the oven ON.
2. Select the pizza cooking function by pressing the Oven function control until the symbol  appears on the display.
3. If necessary, press “+” or “-” controls to adjust the temperature setting.

Defrosting

The oven fan operates without heat and circulates the air, at room temperature, inside the oven. This increases the speed of defrosting. However, please note that the temperature of the kitchen will influence the speed of defrosting. This function is particularly suitable for defrosting delicate food which could be damaged by heat, e.g. cream filled gateaux, iced cakes, pastries, bread and other yeast products.

1. Switch the oven ON.
 2. Select the defrosting by pressing the Oven function control until the symbol  appears in the display.
 3. The display will show the indication “DEF”.
- Cover food with a lid, aluminium foil or plastic film to prevent drying out during defrosting.
 - ALWAYS COOK THOROUGHLY IMMEDIATELY AFTER THAWING.
 - Frozen food should be placed in a single layer when ever possible and turned over half way through the defrosting process.
 - Only joints of meat and poultry up to 2 kg. (4 lb.) are suitable for defrosting in this way.

Hints and Tips

On baking:

Cakes and pastries usually require a medium temperature (150°C-200°C) and therefore it is necessary to preheat the oven for about 10 minutes.

Do not open the oven door before 3/4 of the baking time has elapsed.

Shortcrust pastry is baked in a springform tin or on a tray for up to 2/3 of the baking time and then garnished before being fully baked. This further baking time depends on the type and amount of topping or filling. Sponge mixtures must separate with difficulty from the spoon. The baking time would be unnecessarily extended by too much liquid.

If two baking trays with pastries or biscuits are inserted into the oven at the same time, a shelf level must be left free between the trays.

If two baking trays with pastries or biscuits are inserted into the oven at the same time, the trays must be swapped and turned around after about 2/3 of the baking time.

On Roasting:

Do not roast joints smaller than 1 kg. Smaller pieces could dry out when roasting. Dark meat, which is to be well done on the outside but remain medium or rare inside, must be roasted at a higher temperature (200°C-250°C).

White meat, poultry and fish, on the other hand, require a lower temperature (150°C-175°C). The ingredients for a sauce or gravy should only be added to the roasting pan right at the beginning if the cooking time is short. Otherwise add them in the last half hour.

You can use a spoon to test whether the meat is cooked: if it cannot be depressed, it is cooked through. Roast beef and fillet, which is to remain pink inside, must be roasted at a higher temperature in a shorter time.

If cooking meat directly on the oven shelf, insert the roasting pan in the shelf level below to catch the juices.

Leave the joint to stand for at least 15 minutes, so that the meat juices do not run out.

To reduce the build up of smoke in the oven, it is recommended to pour a little water in the roasting pan. To prevent condensation forming, add water several times. The plates can be kept warm in the oven at minimum temperature until serving.



Caution!

Do not line the oven with aluminium foil and do not place a roasting pan or baking tray on the floor, as otherwise the oven enamel will be damaged by the heat build-up.

Cooking times

Cooking times can vary according to the different composition, ingredients and amounts of liquid in the individual dishes.

Note the settings of your first cooking or roasting experiments to gain experience for later preparation of the same dishes.

Based upon your own experiences you will be able to alter the values given in the tables.



Baking table

Conventional and Fan Cooking



Timings do not include pre-heating.

The empty oven should always be pre-heated for 10 minutes.

TYPE OF DISH	Conventional Cooking		Fan Cooking		Cooking times in minutes 	NOTES
	 4 3 2 1	temp °C	 4 3 2 1	temp °C		
CAKES						
Whisked recipies	2	170	2 (1and3)*	160	45-60	In cake mould
Shortbread dough	2	170	2 (1and3)*	160	20-30	In cake mould
Butter-milk cheese cake	1	175	2	165	60-80	In cake mould
Apple cake (Apple pie)	1	170	2	160	90-120	In cake mould
Strudel	2	180	2	160	60-80	In baking tray
Jam- tart	2	190	2(1and3)*	180	40-45	In cake mould
Fruit cake	2	170	2	150	60-70	In cake mould
Sponge cake	1	170	2(1and3)*	165	30-40	In cake mould
Christmas cake	1	150	2	150	120-150	In cake mould
Plum cake	1	175	2	160	50-60	In bread tin
Small cake	3	170	2	160	20-35	In baking tray
Biscuits	2	160	2(1and3)*	150	20-30	In baking tray
Meringues	2	135	2(1and3)*	150	60-90	In baking tray
Buns	2	200	2	190	12~20	In baking tray
Pastry: Choux	2 or 3	210	2(1and3)*	170	25-35	In baking tray
Plate tarts	2	180	2	170	45-70	In cake mould
BREAD AND PIZZA						
White bread	1	195	2	185	60-70	
Rye bread	1	190	1	180	30-45	In bread tin
Bread rolls	2	200	2(1and3)*	175	25-40	In baking tray
Pizza	2	200	2	200	20-30	In baking tray
FLANS						
Pasta flan	2	200	2(1and3)*	175	40-50	In mould
Vegetable flan	2	200	2(1and3)*	175	45-60	In mould
Quiches	1	210	1	190	30-40	In mould
Lasagne	2	200	2	200	25-35	In mould
Cannelloni	2	200	2	200	25-35	In mould

This chart is intended as a guide only. It may be necessary to increase or decrease the temperature to suit your individual requirements. Only experience will enable you to determine the correct setting for your personal requirements. If you wish to cook more than one dish at the same time, we suggest that you change the cooking levels of your dishes during the last 5-10 minutes in order to obtain a more uniform colour of your dishes.



(*) If you need to cook more than one dish at the same time, we recommend you to place them on the levels quoted between brackets. Shelf positions are counted from bottom of the oven.

Roasting Table

Conventional and Fan Cooking



Timings do not include pre-heating.
The empty oven should always be pre-heated for 10 minutes.

TYPE OF DISH	Conventional Cooking		Fan Cooking		Cooking times in minutes 	NOTES
	 temp °C	temp °C	 temp °C	temp °C		
MEAT						
Beef	2	190	2	175	50-70	On grid
Pork	2	180	2	175	100-130	On grid
Veal	2	190	2	175	90-120	On grid
English roast beef						
rare	2	210	2	200	50-60	On grid
medium	2	210	2	200	60-70	On grid
well done	2	210	2	200	70-80	On grid
Shoulder of pork	2	180	2	170	120-150	With rind
Shin of pork	2	180	2	160	100-120	2 pieces
Lamb	2	190	2	175	110-130	Leg
Chicken	2	190	2	200	70-85	Whole
Turkey	2	180	2	160	210-240	Whole
Duck	2	175	2	220	120-150	Whole
Goose	2	175	1	160	150-200	Whole
Rabbit	2	190	2	175	60-80	Cut in pieces
Hare	2	190	2	175	150-200	Cut in pieces
Pheasant	2	190	2	175	90-120	Whole
Meat loaf	2	180	2	170	tot.150	in bread pan
FISH						
Trout/Sea bream	2	190	2(1and3)*	175	40-55	3-4 fishes
Tuna fish/Salmon	2	190	2(1and3)*	175	35-60	4-6 fillets

(*) If you cook more than one dish at the same time, we recommend you place them on the levels quoted between brackets.



The temperatures quoted are guidelines. The temperatures may have to be adapted to personal requirements.

Conventional Grilling



Timings do not include pre-heating.

The empty oven should always be pre-heated for 10 minutes.

TYPE OF DISH	Quantity		Grilling		Cooking time in minutes	
	Pieces	g.		temp.°C	1st side	2nd side
Fillet steaks	4	800	3	250	12-15	12-14
Beef-steaks	4	600	3	250	10-12	6-8
Sausages	8	/	3	250	12-15	10-12
Pork chops	4	600	3	250	12-16	12-14
Chicken (cut in two)	2	1000	3	250	30-35	25-30
Kebabs	4	/	3	250	10-15	10-12
Chicken (breast)	4	400	3	250	12-15	12-14
Hamburger*	6	600	2	250	20-30	
*Preheat 5'00"						
Fish (fillets)	4	400	3	250	12-14	10-12
Sandwiches	4-6	/	3	250	5-7	/
Toast	4-6	/	3	250	2-4	2-3

Thermal Grilling



With Thermal Grilling select a maximum temperature of 200°C.

TYPE OF DISH	Quantity		Thermal Grilling		Cooking time in minutes	
	Pieces	g.		temp.°C	1st side	2nd side
Rolled joints (turkey)	1	1000	3	200	30-40	20-30
Chicken (cut in two)	2	1000	3	200	25-30	20-30
Chicken legs	6	--	3	200	15-20	15-18
Quail	4	500	3	200	25-30	20-25
Vegetable gratin	--	--	3	200	20-25	--
St. Jacques shells	--	--	3	200	15-20	--
Mackerel	2-4	--	3	200	15-20	10-15
Fish slices	4-6	800	3	200	12-15	8-10

Pizza Function

TYPE OF DISH	Pizza Function		Cooking time in minutes	NOTES
		temp.°C		
Pizza , large	1	200	15-25	on baking tray
Pizza , small	1	200	10-20	on baking tray or on grid
Bread rolls	1	200	15-25	on baking tray



The temperatures quoted are guidelines. The temperatures may have to be adapted to personal requirements.

Cleaning and Maintenance



Before cleaning always allow the cooling fan to cool the oven down before switching off at the electricity supply.

The oven should be kept clean at all times. A build-up of fats or other foodstuffs could result in a fire, especially in the grill pan.

The appliance must not be cleaned with a superheated steam cleaner or a steam jet cleaner.

Important: Before carrying out any cleaning operation, the appliance must be disconnected from the power supply.

To ensure a long life for your appliance, it is necessary to perform the following cleaning operations regularly:

- Only perform when the oven has cooled down.
- Clean the enamelled parts with soapy water.
- Do not use abrasive cleaners.
- Dry the stainless steel parts and glass with a soft cloth.
- If there are stubborn stains, use commercially available for stainless steel or warm vinegar.

The oven's enamel is extremely durable and highly impermeable. The action of hot fruit acids (from lemons, plums or similar) can however leave permanent, dull, rough marks on the surface of the enamel. However such marks in the brightly polished surface of the enamel does not affect the operation of the oven. Clean the oven thoroughly after every use. This is the easiest way to clean dirt off. It prevents dirt being burnt on.

Cleaning materials

Before using any cleaning materials on your oven, check that they are suitable and that their use is recommended by the manufacturer.

Cleaners that contain bleach should NOT be used as they may dull the surface finishes. Harsh abrasives should also be avoided.

External cleaning

Regularly wipe over the control panel, oven door and door seal using a soft cloth well wrung out in warm water to which a little liquid detergent has been added.

To prevent damaging or weakening the door glass panels avoid the use of the following:

- Household detergent and bleaches
- Impregnated pads unsuitable for non-stick saucepans
- Steel wool pads
- Chemical oven pads or aerosols
- Rust removers
- Bath/Sink stain removers

Clean the outer and inner door glass using warm soapy water. Should the inner door glass become heavily soiled it is recommended that a cleaning product such as Hob Brite is used. Do not use paint scrapers to remove soilage.

Oven Cavity

The enamelled base of the oven cavity is best cleaned whilst the oven is still warm.

Wipe the oven over with a soft cloth soaked in warm soapy water after each use. From time to time it will be necessary to do a more thorough cleaning, using a proprietary oven cleaner.

Pyrolytic cleaning

The oven cavity is coated with a special enamel resistant to high temperatures.

During the pyrolytic cleaning operation, the temperature inside the oven can reach about 500 °C thus burning food residuals.

For your security, during the pyrolytic cleaning operation, the oven door automatically locks when the temperature inside the oven approaches about 300 °C.

Upon completion of the cleaning operation, the oven door will be locked until the oven cavity has cooled down.

The cooling fan operates until the oven has cooled down. After cooking, it is advisable to remove all the food residues with a wet sponge.

However, from time to time, it will be necessary to do a more complete and thorough cleaning, using the pyrolytic cleaning function. You can select two different levels of pyrolytic cleaning depending on how dirty the oven is.

If the oven cavity is not very dirty, we recommend that you select the pyrolytic 1 function (P1) in the programmer display.

It is advisable to wipe the oven over with a soft sponge soaked in warm water after each pyrolytic cleaning cycle is carried out.

If the oven cavity is very dirty, we advise you to select the pyrolytic 2 function (P2) in the programmer display.

During the pyrolytic cleaning function, it is not possible to use the oven for 2 hours when selecting the P1 function and up to 2 1/2 hours when the P2 function is active.





After a significant number of cooking, the cleaning reminder suggests to activate a pyrolytic cleaning cycle. The „Pyro“ message will appear in the display and an acoustic signal will be emitted for about 15 seconds.

Select the type of pyrolytic cycle depending on how dirty the oven is. The reminder message will be displayed each time the oven is switched off until a complete pyrolytic cleaning cycle is performed.

How to use the pyrolytic cleaning function

 Before activating the pyrolytic cleaning function, remove any excessive spillage and make sure that the oven is empty. Do not leave anything inside it (e.g. pans, grids, baking tray, dripping pan, etc.) as this could heavily damage them.

 Ensure that the oven door is closed before activating the pyrolytic cleaning function.

 When the pyrolytic cleaning function is on, it is advisable not to use the hob as this could cause overheating and damage the appliance.

 During the pyrolytic cleaning cycle the oven door becomes hot. Children should be **kept away** until it has cooled.

 If the oven has been installed under a built-in hob, do not switch the hob cooking zones on while pyrolytic cleaning is running.

Choose this function to clean the oven by pyrolysis.



The following pyro levels are available:

Pyrolytic 1 (P 1) time : 2 h = 30 min heat-up + 1 h at 480°C + 30 min cooling down.

Pyrolytic 2 (P 2) time : 2 h 30 min. = 30 min heat-up + 1 h 30 min at 480°C + 30 min cooling down.

The pyro duration time cannot be changed.



To activate the pyrolytic cleaning function proceed as follows:

1. Press button  to switch on the oven. Press the **Oven function** button as often as necessary, until the "Pyro" function symbol  (level 1 - P 1) will appear in the display.

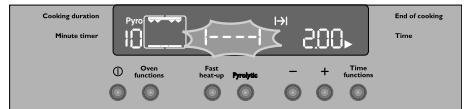
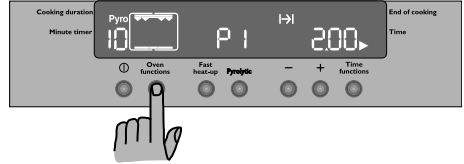
Simultaneously, the symbol  and the "P 1" writing will flash in the display and an acoustic signal will be emitted.



This means that, before activating the pyrolytic cleaning function, you have to remove all the oven accessories.

- The Cooking Duration symbol  will flash for 5 seconds; during this time push '-' or '+' buttons to select the pyrolytic 1 (P1) or pyrolytic 2 (P2) function.
- Once you have chosen the desired pyrolytic function, the "P1" or "P2" writing will flash in the display, alternating with the symbol , waiting for confirmation to start the pyro cleaning function.
- To confirm which pyrolytic function you desire, press Pyrolytic button. The writing will stop flashing and the symbol  will disappear, the acoustic signal will stop, the oven lamp will switch off and the pyrolytic cleaning cycle starts.

As soon as the oven heats up, the thermometer symbol  rises slowly, indicating that the temperature inside the oven is increasing.

- When temperature inside the oven reaches 300°C, the door lock will be activated and the related symbol  will be displayed.

At the end of the pyrolytic cleaning process, the display shows the time of day. The oven door is locked.

Once the oven has cooled down, an acoustic signal will be emitted and the door will unlock.

To stop the pyrolytic cleaning cycle at any time, press button .

NOTE: The time indication includes the cooling down time.



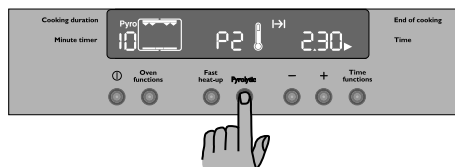
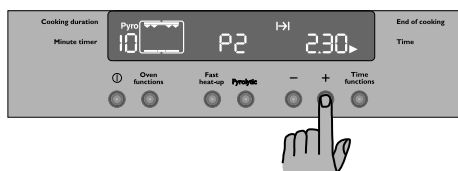

 If you select a cooking function while the pyrolytic function is active, the cleaning cycle will be interrupted.



If the oven door lock is activated, it is impossible to select any cooking function until the door lock is off.





To programme the pyrolytic cleaning cycle (delayed start, automatic stop)

If you desire, you can programme the starting and ending time of the pyrolytic cleaning cycle.

1. Press button  to switch on the oven. Press the **Oven function** button as often as necessary, until the "Pyro" function symbol  (level 1 - P 2) appears in the display. Simultaneously the "P 1" writing and the symbol  will flash in the display and an acoustic signal will be emitted. This means that, before activating the pyrolytic cleaning function, you have to remove all the oven accessories.
2. The Cooking Duration symbol  will flash for some seconds; during this time push '-' or '+' buttons to select the pyrolytic 1 (P 1) or pyrolytic 2 (P 2) function.
3. Once you have chosen the desired pyrolytic function, the "P1" or "P2" writing will flash in the display, alternating with the symbol , waiting for confirmation to start the pyrolytic cleaning function.

At this time, push the time function button Time Functions The "End of Cooking" symbol  and the arrow symbol  will flash. The control panel will display the end of the cleaning cycle (that is, the actual time + cooking duration time).

Push '-' or '+' buttons to select the required end of cycle time. After a few seconds, the "Pyro" writing and the symbol  will stop flashing, the acoustic signal will stop while the Cooking Duration symbol  will flash until the pyrolytic cleaning cycle start.

4. At the programmed time, the pyrolytic cleaning cycle will automatically start.

5. When temperature inside the oven reaches 300°C, the door lock will be activated and the related symbol  will be displayed.

At the end of the pyrolytic cleaning process, the display shows the time of day. The oven door is locked.

Once the oven has cooled down, an acoustic signal will be emitted and the door will unlock.

To stop the pyrolytic cleaning cycle at any time, press button .

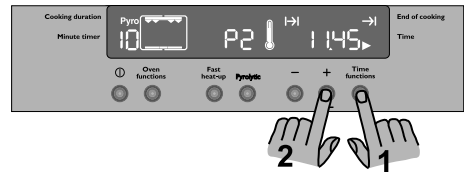

The oven door

The oven door consists of four panes of glass. The oven door can be disassembled and the internal panes can be removed to make cleaning easier.



Important - Remove the oven door before cleaning it. The oven door could abruptly close if you try to remove the internal panes of glass when the door is still assembled.



To do so, proceed as follows.

1. open the door fully;
2. Locate the two door hinges (Fig. 1).
3. Lift and turn the levers on the two hinges (Fig. 2).
4. Hold the door by the side edges and close it slowly but not COMPLETELY (Fig. 3).
5. Pull the door forward, removing it from its seat (Fig. 3).
6. Place the door on a stable surface protected by a soft cloth to prevent the handle surface from being damaged (Fig. 4).

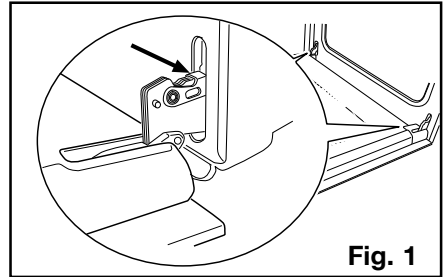

Fig. 1

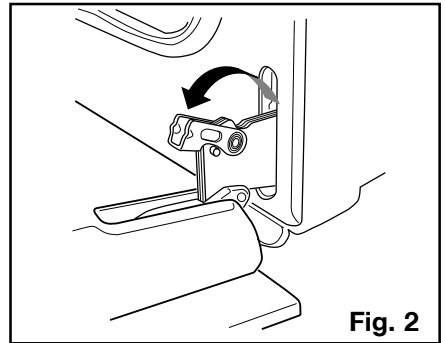

Fig. 2

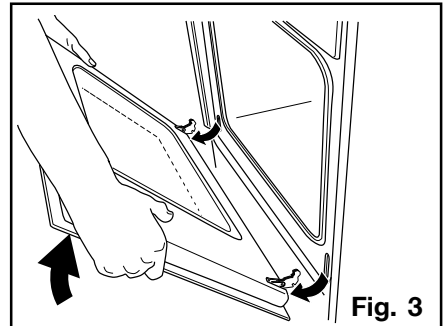

Fig. 3

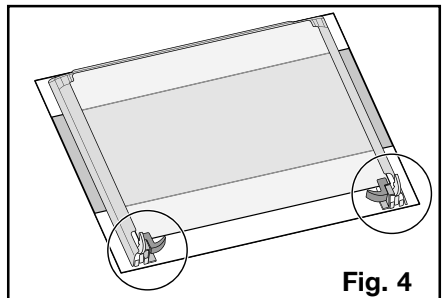

Fig. 4

- 7. Release the locking system to remove the internal panes of glass (Fig. 5).
- 8. Turn the 2 fasteners 90° and extract them from their seats (Fig. 6).
- 9. Gently lift and carefully take off the uppermost pane (Fig. 7).

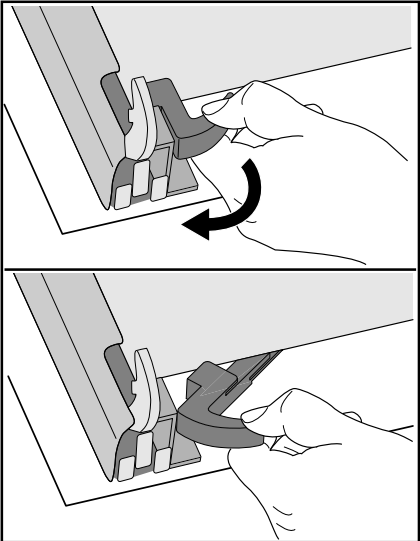

Fig. 5

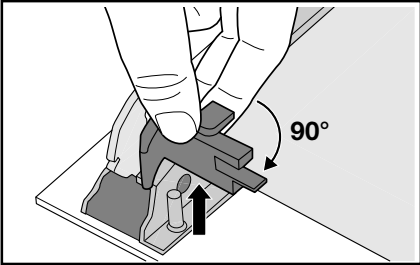

Fig. 6

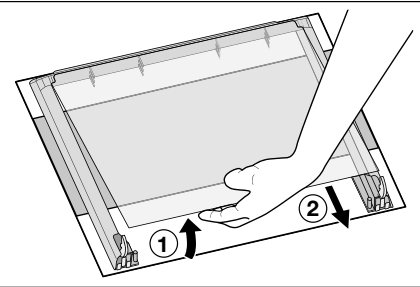



Fig. 7

10. Repeat the procedure described in point 9. for the middle pane marked by a decorative frame on 4 sides (Fig. 8).
11. Gently lift and carefully take off the innermost pane (Fig. 9).

Clean the oven door with lukewarm water and a soft cloth. Do not use products such as scouring pads, steel wool, abrasive sponges or acids because they could damage the special heat-reflecting surface of the internal panes of glass.

After cleaning, reassemble the panes in the door and then the oven door, following the procedure described above in reverse. Make sure you reposition the panes correctly.

 To perform this operation correctly, proceed as follows:

- a) the clear innermost pane must be reassembled so that the screen-printed symbol in one corner is placed in the upper left-hand corner as shown in Fig. 10a.
- The middle pane must be put back into the right seat as shown in Fig. 10b.

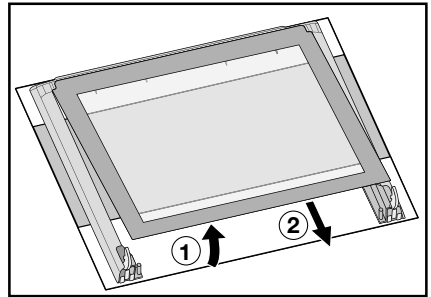

Fig. 8

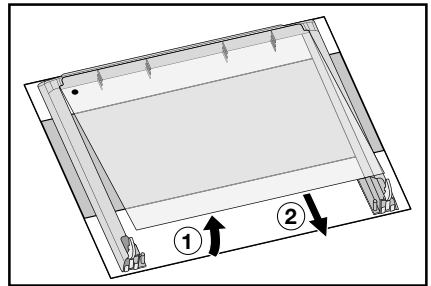

Fig. 9

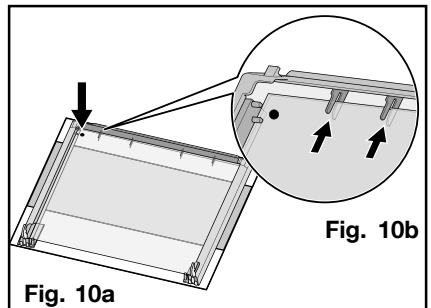

Fig. 10a

Fig. 10b

- b) the decorated middle pane with a frame on the 4 sides must be reassembled so that the screen-printing is facing outwards. The side of the pane of glass is correct if you do not feel any roughness near the screen printing when you pass your fingers over the surface.

The middle pane of glass must be put back into the right seats as shown in Fig. 11.

- c) the uppermost pane must be reassembled as shown in Fig. 12.

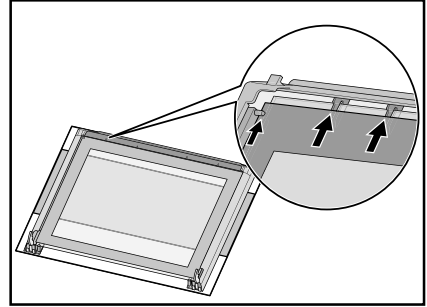

Fig. 11

After the panes of glass have been reassembled in the oven door, perform the procedure described in point 8. in reverse to ensure they are locked.

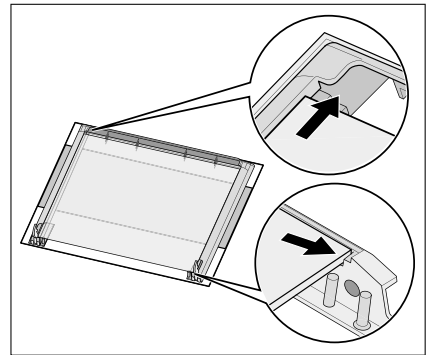

Fig. 12

Oven Shelves and Shelf Supports

The shelf support rails on the left and right hand sides of the oven can be removed for cleaning the side walls.

Removing the shelf support rails

First pull the front of the rail away from the oven wall and then unhitch at the back (1, 2).

Fitting the shelf support rails

To install, first reattach the rails at the back, then put them into position at the front and press them into place (3). To clean the shelf support rails, soak in warm soapy water and remove stubborn marks with a well wetted soap impregnated pad. Rinse well and dry with a soft cloth.



Remove the shelf supports and all oven accessories before activating the pyrolytic cleaning cycle.

Replacing the oven light

Disconnect the appliance

If the oven bulb needs replacing, it must comply with the following specifications:

- Electric power: 40 W,
- Electric rate: 230 V (50 Hz),
- Resistant to temperatures of 300°C,
- Connection type: E14.

These bulbs are available from your local Service Force Centre.



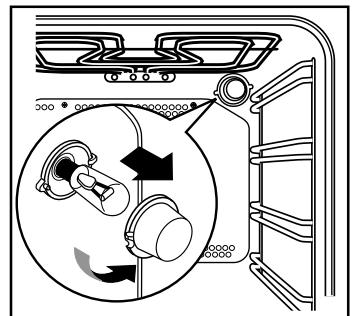
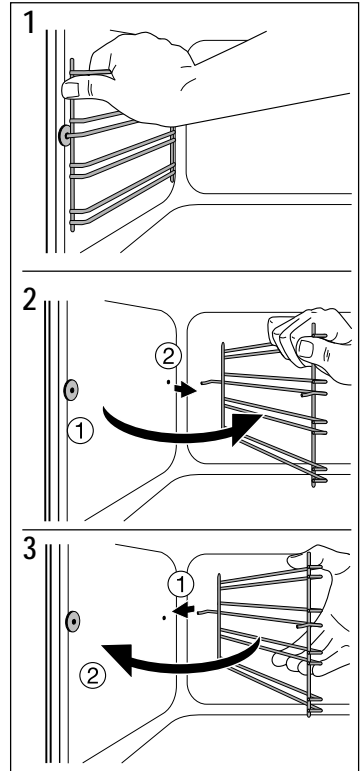

To replace the faulty bulb:

1. Ensure the oven is isolated from the electrical supply.
2. Push in and turn the glass cover anticlockwise.
3. Remove the faulty bulb and replace with the new one.
4. Refit the glass cover and restore the electrical supply.



Something not working

If the appliance is not working correctly, please check the following before contacting an authorised Service Centre.

PROBLEM	SOLUTION
<ul style="list-style-type: none"> ■ The oven is not heating up. 	<ul style="list-style-type: none"> ◆ Press the  control, then select a cooking function. <li style="text-align: center;"><i>or</i> ◆ Has the fuse in the domestic electrical installation been tripped? <li style="text-align: center;"><i>or</i> ◆ Is the child safety device or the automatic On/Off cut-off function switched on? <li style="text-align: center;"><i>or</i> ◆ Was the Demo function accidentally activated? Follow the instructions given in the relevant paragraph to deactivate it. <li style="text-align: center;"><i>or</i> ◆ Check whether the appliance is correctly connected and the socket switch or the mains supply to the oven is ON.
<ul style="list-style-type: none"> ■ The oven light does not come on. 	<ul style="list-style-type: none"> ◆ Switch on the oven using control . <li style="text-align: center;"><i>or</i> ◆ Check the light bulb, and replace it , if necessary (see chapter "Cleaning and Maintenance").
<ul style="list-style-type: none"> ■ It takes too long to cook the dishes or they cook too quickly. 	<ul style="list-style-type: none"> ◆ Following the advice contained in these instructions, especially the section "Using the oven".
<ul style="list-style-type: none"> ■ Steam and condensation settle on the food and in the oven cavity. 	<ul style="list-style-type: none"> ◆ When the cooking process is completed, do not leave the dishes standing in the oven for longer than 15-20 minutes.
<ul style="list-style-type: none"> ■ The oven fan is noisy. 	<ul style="list-style-type: none"> ◆ Check that shelves and bakeware are not vibrating in contact with the oven back panel.
<ul style="list-style-type: none"> ■ The display shows "12.00". 	<ul style="list-style-type: none"> ◆ Set the time of day (see chapter "How to set the time of day").
<ul style="list-style-type: none"> ■ The error code (letter "F followed by digits) appears in the display. 	<ul style="list-style-type: none"> ◆ Please take note of the error code and contact an authorised Service Centre.

Technical data

Heating element ratings

Bottom	1000 W
Top	800 W
Conventional cooking (top+bottom)	1800 W
Inner Grill	1650 W
Full grill	2450 W
Fan cooking	2000 W
Pizza	1000/2000 W
Thermal Grilling	1675 W
Pyrolytic Cleaning Function	2450 W
Oven light	40 W
Convection fan	25 W
Cooling fan	25 W
Total rating	2515 W
Operating voltage (50 Hz)	230 V

Dimensions of the recess

Height	under top	593 mm
	in column	580 mm
Width		560 mm
Depth		550 mm

Dimensions of the oven cavity

Height	335 mm
Width	395 mm
Depth	400 mm
Oven capacity	53 l

Electrical Connection



The oven must be installed according to the instructions supplied.



This oven must be installed by qualified personnel to the relevant British Standards.

The oven is designed to be connected to 230V (50 Hz) electricity supply.

The oven has an easily accessible terminal block which is marked as follows:

Letter L - Live terminal

Letter N - Neutral terminal

 or E - Earth terminal



THIS OVEN MUST BE EARTHED

The cable used to connect the oven to the electrical supply must comply to the specifications given below.

It is necessary that you install a double pole switch between the oven and the electricity supply (mains), with a minimum gap of 3mm between the switch contacts and of a type suitable for the required load in compliance with the current rules.

The switch must not break the yellow and green earth cable at any point.

the yellow and green earth cable should be 2-3 cm longer than the other cables.

Important

After installation and connecting, the cable must be placed so that it cannot at any point reach a temperature of more than 50°C above the ambient temperature.

Before the oven is connected, check that the main fuse and the domestic installation can support the load and that the power supply is properly earthed.

The manufacturer declines any responsibility should these safety measures not be carried out.

Connection via	Min. size Cable/flex	Cable / flex type	Fuse
13 A socket outlet	2.5 mm ²	3 core butyl insulated	13 A min.
13 A spur box			
Oven Control Circuit	2.5 mm ²	PVC/PVC twin and earth	15 A min. 20 A max.

For Europe use only

Min. size Cable/flex	Cable / flex type	Fuse
2.5 mm ²	H07 RN-F, H05 RN-F, H05 RR-F, H05 VV-F, H05 V2V2-F (T90), H05 BB-F	15 A

Instructions for Building In

Please ensure that when the oven is installed it is easily accessible for the engineer in the event of a breakdown.

Building In

The surround or cabinet into which the oven will be built must comply with these specifications:

- the dimensions must be as shown in the relevant diagrams;
- the materials must withstand a temperature increase of at least 60 °C above ambient;
- proper arrangements must be made of a continuous supply of air to the oven to prevent the oven overheating.

Dimensions of the oven and recess required are given in the relevant diagrams.

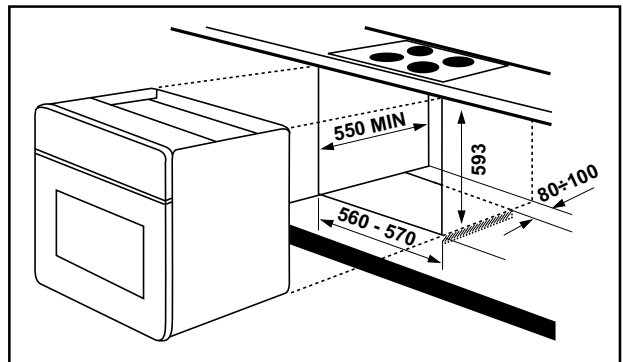
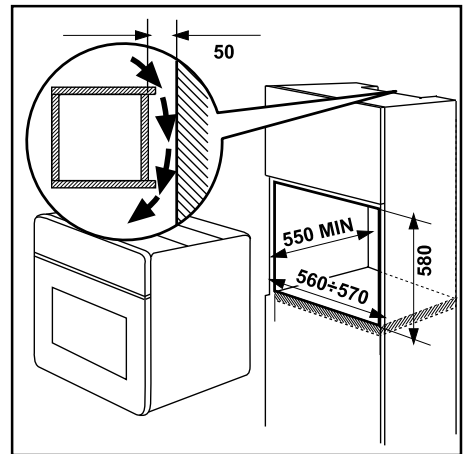
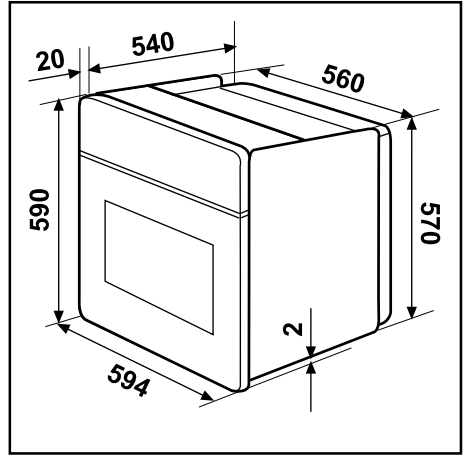

Securing the Appliance to the Cabinet

- Open the oven door;
- fasten the oven to the cabinet placing the four distance holders (Fig.D - A) which fit exactly into the holes in the frame and then fit the four wood screws (Fig. D - B) provided.

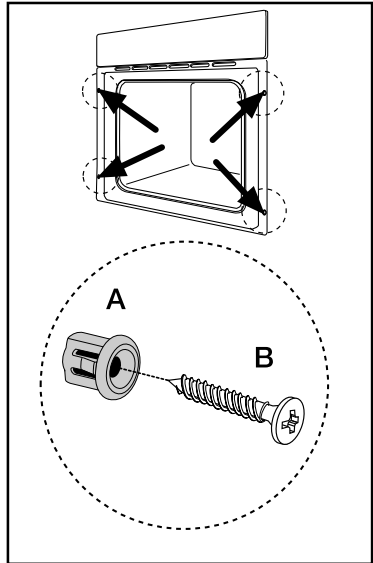

Fig. D

John Lewis Partnership
171 Victoria Street
London SW1E 5NN
www.johnlewis.com